

# INSTALLATION INSTRUCTIONS

100mm Standard and Timer  
Conceal Silent Fans

**Switch off mains supply before making any electrical connections.**

**Installation must be supervised by a qualified electrician.**

**This appliance can be used by children aged from 8 years and above and persons with reduced physical, sensory and mental capabilities or lack of experience and knowledge if they have been given supervision or instruction concerning the use of the appliance in a safe way and understand the hazards involved.**

**Children shall not play with the appliance.**

**Cleaning and user maintenance shall not be made by children without supervision.**

**Precautions must be taken to avoid the back-flow of gases into the room from the open flue of gas or other open-fire appliances when mounted in outside windows or walls.**

**Fan must be disconnected from electrical power before any maintenance is carried out.**

## Location

1. When installing fan through an external wall, an external wall grille must be fitted at all times.
2. For best results this Extractor Fan should be fitted as high on the wall as possible, or if preferred, on the ceiling. Note: Pullcord models should not be installed in a ceiling.
3. Where ducted fans are used to handle moisture-laden air, such as a bathroom, a condensation trap should be fitted in any vertical exhaust ducts. Horizontal ducts should be arranged to slope slightly away from the fan. Ducts passing through cold voids must be suitably insulated.
4. Do not install the unit within a shower cubicle or anywhere else where there is a risk of being sprayed with water (Please see our range of showerfans for these installations.).
5. If the fan is installed in a room containing a fuel burning appliance, the installer must ensure that the air replacement is adequate for both the fan and the fuel burning appliance.

## Wiring

1. Switch off mains supply before making electrical connections. If in any doubt contact a qualified electrician.
2. These units are for fixed wiring only. A flexible cord must not be used. All wiring must be fixed securely and the cable to the fan should be a minimum of 1mm<sup>2</sup> in section. All wiring must comply with current I.E.E. Regulations or local regulations if outside the UK.
3. A double pole fused spur having contact separation of at least 3mm in all pole must be used and fitted with a 3A fuse.
4. This fan is double insulated and does not require an earth connection.
5. The fan should not be accessible to a person using either the shower or the bath.

## **IMPORTANT: READ THESE INSTRUCTIONS BEFORE COMMENCING THE INSTALLATION**

DO NOT - install this product in areas where the following may be present or occur:

- Excessive oil or a grease laden atmosphere.
- Corrosive or flammable gases, liquids or vapours.
- Ambient temperatures higher than 40°C or less than -5°C.
- Possible obstructions which would hinder the access or removal of the Fan.

### **INSTALLATION**

#### **PANEL/CEILING MOUNTING**

1. For panel/ceiling mounting the fan should be installed into a closed duct system of at least 1.2m long or protected by an exterior air grille that must comply with the standard requirements of your country to prevent access to the fans impeller.
2. Cut a 105mm diameter hole.
3. Loosen the screw at the bottom of the grille and remove the front grille. Mark the screw centres through the holes in the fan back plate. Drill, plug and screw into position.
4. Attach ducting as required for the installation.
5. Wire the fan as described in the Wiring section.
6. After installation, ensure impeller rotates freely.
7. Replace the grille and tighten the retaining screw.

#### **WALL MOUNTING**

1. For wall mounting cut a 115mm diameter hole through the wall and insert the wall sleeve. Slope the sleeve slightly downwards away from the fan. Cut to length and cement both ends into position flush with the wall faces.
2. Loosen the screw in the bottom of the grille and remove the front grille. Mark the screw centres through the holes in the fan back plate. Drill, plug and screw into position.
3. Fix exterior grille into position with the louvres positioned downwards. (Note:- The grille must comply with the standard requirements of your country to prevent access to the fans impeller).
4. Wire the fan as described in the wiring section. Adjust any settings as required.
5. After installation, ensure impeller rotates freely.
6. Replace the grille and tighten the retaining screw.

### **WIRING.**



**WARNING: THE FAN AND ANCILLARY CONTROL EQUIPMENT MUST BE ISOLATED FROM THE POWER SUPPLY DURING THE INSTALLATION / OR MAINTENANCE.**

- The cross - sectional area of supply cord used should be between 1 - 1.5mm<sup>2</sup>.
  - Cable entry can only be made from the rear of the fan.
  - The extraction fan is suitable for connection to 220-240V 50Hz supply.
  - The fan is a class II double insulated product and MUST NOT be earthed.
1. Select and follow the appropriate wiring diagram.
  2. Check all connections have been made correctly and ensure all terminal connections and cable clamps are securely fastened before switching on the electrical supply.

**To remove cover:**

1. Loosen the screw at the bottom of the fan

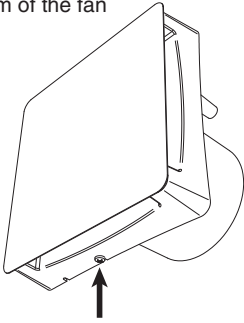

2. Lift the bottom of the cover gently out

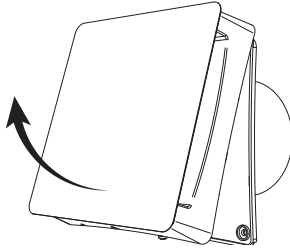

3. Lift the cover up and away.

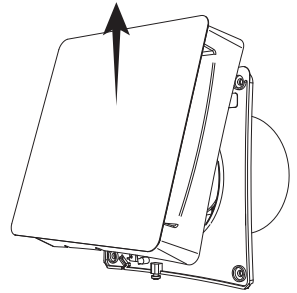

**Standard Fan Wiring  
Live and Neutral Only**

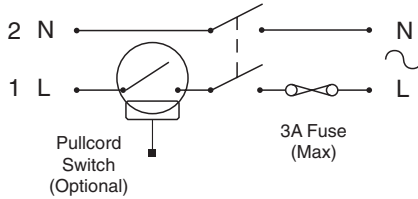

Single Phase Supply  
220 - 240 VAC  
50Hz

**Timer Fan Wiring  
Live, Neutral and Switched Live**

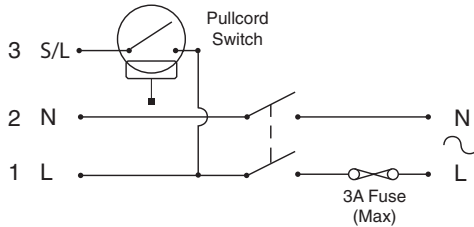

Single Phase Supply  
220 - 240 VAC  
50Hz

**Speed Setting:**

The fan has two speed settings, at the factory they are set to low-speed, to change speed settings gently slide the jumper downwards and reposition it on the appropriate pegs:

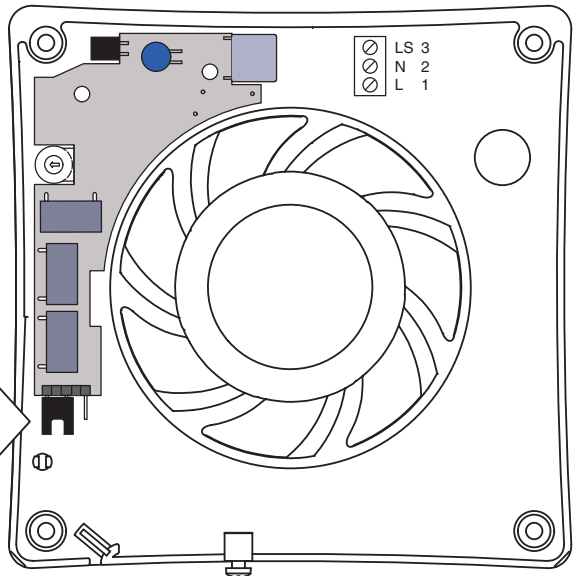
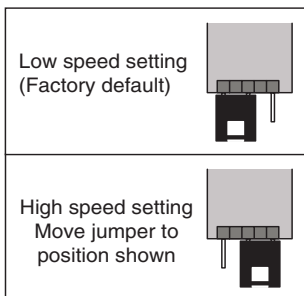

## TIMER ADJUSTMENT (CSF100T ONLY)

BEFORE ADJUSTING THE TIMER, SWITCH OFF THE MAINS SUPPLY. TIMER SHOULD ONLY BE ADJUSTED BEFORE OR DURING INSTALLATION.

1. Remove the fan grille. The timer is factory set at 15 minutes approx. The overrun time period can be adjusted from 5-30 minutes by altering the adjuster on the control PCB with a small flat bladed screwdriver.
2. To REDUCE the operating time, turn the adjuster. ANTI-CLOCKWISE.
3. To INCREASE the operating time, turn the adjuster. CLOCKWISE.
4. Replace the fan grille.

