

# Kair Single Room Heat Recovery Ventilator

## Model:









KHRV150/12RH - Pullcord & Humidistat



## INSTALLATION & MAINTENANCE INSTRUCTIONS

Please read and save these instructions

### Included items

	Description	Qty
	Through Wall unit	x1
	Transformer & humidity sensor	x1
	Blanking Plate (optional)	x1
	Wall Mounting Screws	x6
	Rawplug	x6
	Tamperproof Screws (optional) <i>For unit and transformer - require KTMPB to use</i>	x7
	Installation and Maintenance instructions	x1
	User Guide	x1

### Contents

Page	Content
1	Safety First Isolating Transformer (Humidity sensor unit).
2	Transformer/Humidity Sensor Unit Siting the Ventilator
3	Installation Outside installation of finisher ring
4 & 5	Inside installation of the finisher ring
6 & 7	Location of the Transformer/Humidity Sensor unit
7	Transformer/Humidity Sensor unit Wiring
8	Light Level Sensor
8, 9 & 10	Maintenance
10	Registration
11	Warranty

**Kair**<sup>®</sup>  
For *Your* Environment



What am I?

# Safety First

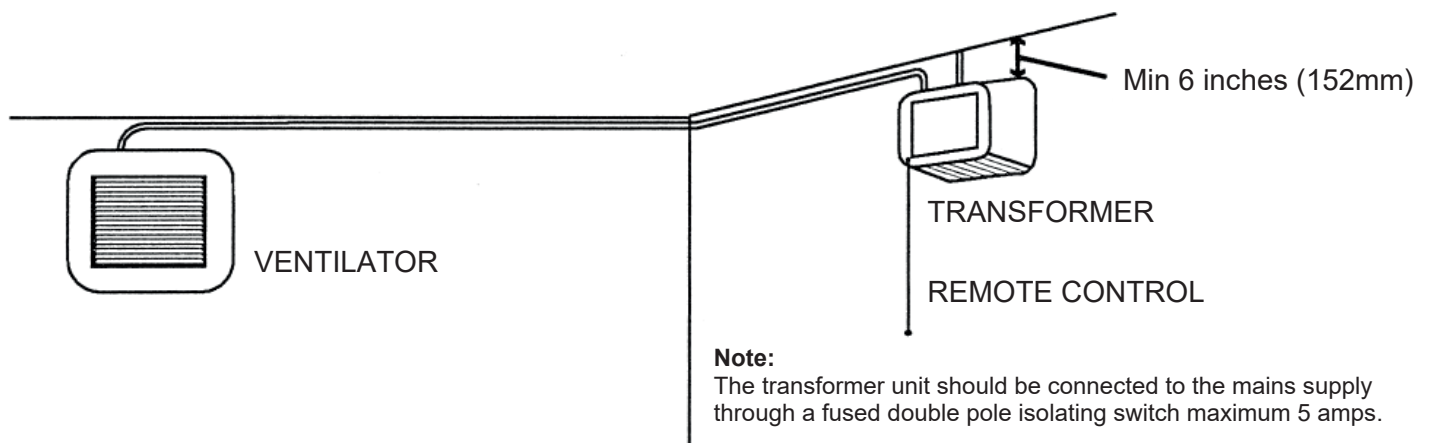

The Heat Recovery Ventilator is a “SELV” (Safety Extra Low Voltage) ventilator that operates at 12 volts AC. Under no circumstances must this be connected directly to the mains supply. Damage so caused is not covered by the warranty. The isolating transformer / humidity sensor supplied must provide the low voltage used by the ventilator. A typical layout of installation is shown above.

The Heat Recovery Ventilator can be used in any room that has an outside wall open to fresh air. It is particularly useful in the bathroom, kitchen or laundry room where high levels of moisture are generated. It can also be used in the lounge, dining room or any bedroom to provide a fresh air supply to reduce dust-mite, eliminate mould growth or dampness and condensation and to provide warmed fresh air.

**IP Ratings:** IP57 SELV Heat exchanger / wall unit    **IP Ratings:** IP30 SELV Transformer

## Isolating Transformer (Humidity sensor unit)

The humidistat monitors the humidity in the room and automatically switches the ventilator from continuous trickle speed to boost if the humidity exceeds the set point e.g. when using the shower, cooking or doing the laundry.

The humidity level setting can be adjusted by turning the thumbwheel (as shown on page 2). We recommend that it is initially set to 50% - 55% which is suitable for most locations. Turning the thumbwheel clockwise towards 90 decreases the sensitivity (fan in boost for shorter time) and anticlockwise towards 20 increases the sensitivity (fan in boost for longer time) and is marked in 10% stages.

To prevent tampering with the setting after installation, the thumbwheel can be removed by carefully pulling upwards. A blanking plate is supplied to seal the hole previously occupied by the thumbwheel.

If installed in a shower or bathroom the transformer / humidistat must be out of reach of anyone using a bath or shower. This unit must be installed by a competent electrician.

# Transformer/Humidity Sensor Unit

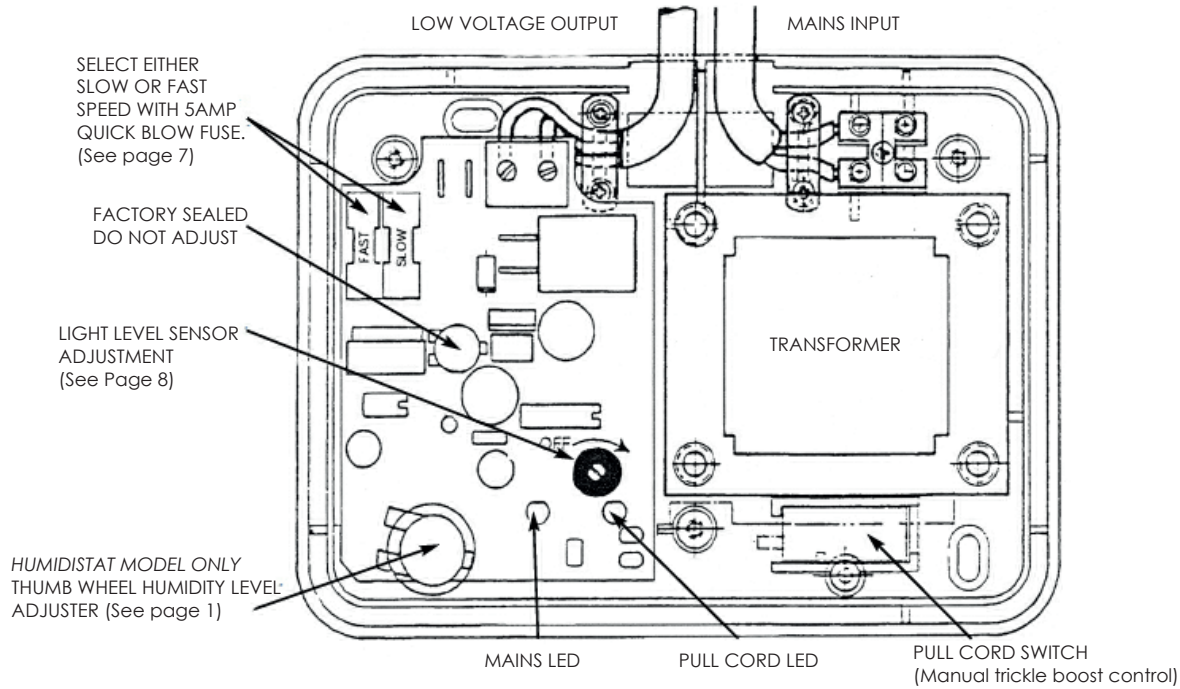

## Siting the Ventilator

- a)** Survey the property carefully and identify the best site for the ventilator. Condensation problems, dampness and mould growth are stimulated by high levels of humidity, the source of which can be the bath / shower room, laundry room, kitchen or possibly a damp wall.

Identify an area in the room with an outside wall, which is clear of obstruction, both inside and out - Check for water and soil pipes, wiring and other obstructions before finalizing your installation position.

The external cowl must be positioned a minimum of 500mm away from any gas flue to avoid back flow of gases.

- b)** Indicate the position of the core drill hole on the inside wall. If possible, mark its position on the outside wall too. See if they look right.

Remember that the Heat Recovery Ventilator is unique in that it both extracts stale, damp air and blows in warmed fresh air. Make sure that steam from your cooker/hob or appliance is not blown away from the fan.

### EXAMPLE

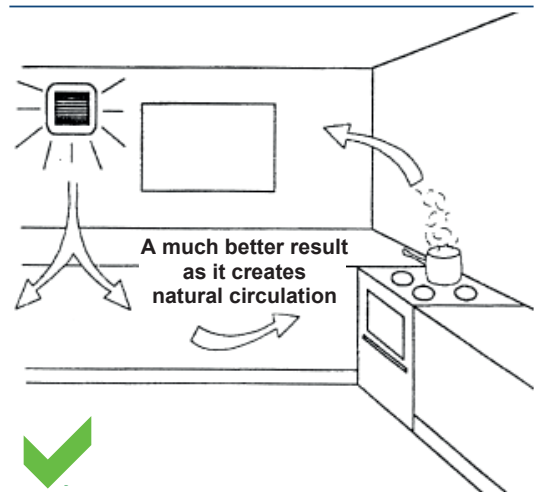
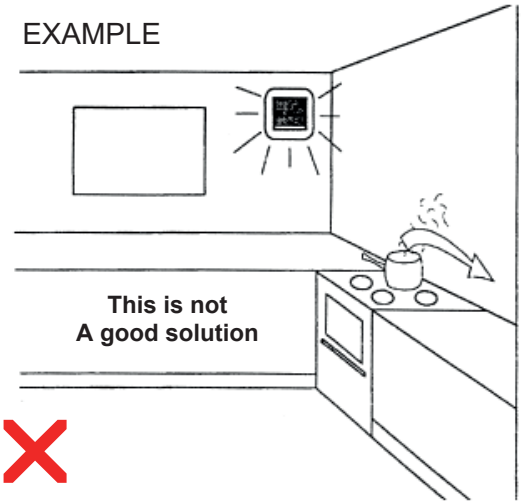

# Installation

- c) You should site the ventilator close to the ceiling. This will ease the installation of the power cable and give you the best position for air circulation.

Use the wall plate as a template, marking the core drill hole, fixing holes and power cable entry position (which should be at the top, left of centre).

- d) The ventilator is designed to be installed using a 6" (152mm) Core Drill system.

The hole needs to be angled downwards very slightly to a maximum of 1.5° or 8mm from the outside where the discharge cowl will allow drainage outside your home.

Drill the hole making sure that masonry does not fall and injure people or damage property below. We recommend the "Duradiamond" Core Drill system, details of stockists available on telephone **01324 814 036**

- e) Measure the length of the hole between the outside brick face and inner plasterwork.

The length should be 4mm greater than the length of the hole 'X' but no less than 254mm, otherwise the Heat Exchanger will not fit. Carefully mark the outer tube all round and cut with a hacksaw and finish off with a file or good quality sand paper, to remove steps and swarf.

Measure the distance 'x' between outside wall and inside plasterwork or tiles

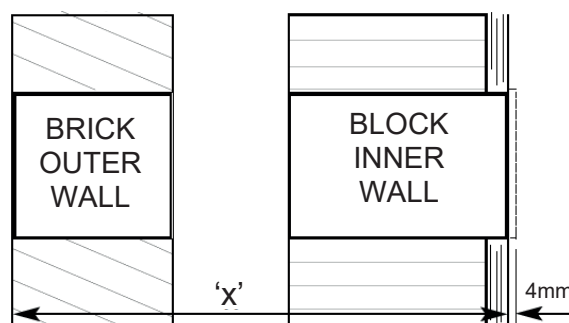

- f) Place the tube in the hole and ensure that it slopes downwards towards the outside wall to allow any condensation to run outwards.

If you have not achieved this you may have to pack the inside end of the tube upwards on final installation.

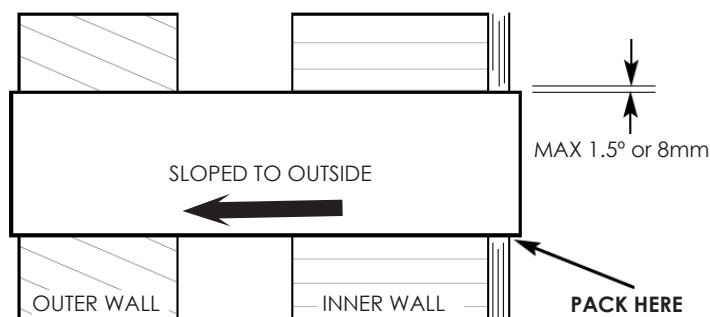

## Outside installation of finisher ring

- g) Place the split finisher around the hole in the outside brickwork with the split at the bottom. Use adhesive to secure the finisher to the wall.

This is best done from the outside but if access is not possible then the split finisher is designed to pass through the large tube.

# Inside installation of the finisher ring

## Proceed as follows:

- i) Push the large tube through the hole so it extends some 50mm beyond the face of the outside wall.
- ii) Apply adhesive around the rear face of the split ring – do not compress the adhesive.

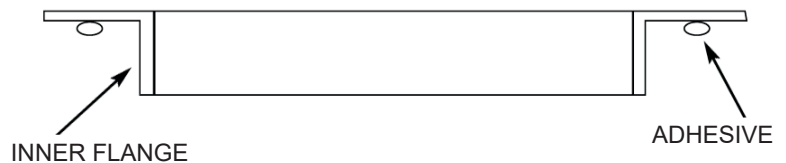

### ENSURE EXTERIOR BRICKWORK IS DUST FREE

- iii) Grip the finisher in your right hand, (palm uppermost) at the left hand end of the split with the adhesive side facing you and the split at the top. Pull back the right hand end of the split along your right arm with your left hand. Push the finisher right through the large tube and let it expand again. Don't let go!

With your right hand, place the inner flange on the outside of the large tube. Move your fingers in an anticlockwise direction until the finisher is pushed fully onto the tube – see picture.

- iv) Then, pull the tube and finisher back towards the room making sure that the split remains at the bottom. Carefully pull the finisher into the gap between tube and brickwork. Press the adhesive gently against the wall, compressing the adhesive somewhat. Then pull the tube into the room leaving the finisher in place. Ensure that the finisher does not fall.

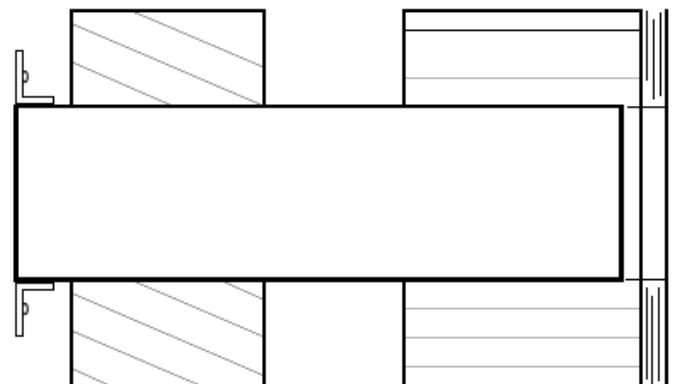

- v) Now manipulate the finisher to expand it outwards and increase its internal diameter as much as possible. This will assist the re-entry of the tube. Compress the adhesive fully against the wall to hold it in position.
- h) Fit the outside cowl to your prepared length of tube using PVC adhesive such as - PVC Pipe weld or similar. This is available from most builders merchants. (Other types of silicone adhesive will probably work just as well). Place the adhesive in an even layer around the inside diameter of the tube at the end that you did not cut. Place the outside louvre vent on the end of the tube and allow the glue to set before handling it again. Wipe off any excess adhesive on the outside of the cowl.
- i) It is important for the correct operation that the smaller diameter tube is the correct length. This tube connects the extraction fan housing to the outside cowl and separates the two air streams. The correct fitting of this tube is critical to the efficient operation of the ventilator. To achieve this, whatever length has been cut off the outer tube, the exact same length must be cut off the inner tube.

Try to cut it as evenly as possible with minimum off set. File or otherwise finish your cut end to remove any offset and swarf.

## Installation - Continued

- j) Mounted on the heat exchanger is a round plastic baffle that secures the air intake filters. The extraction fan adjacent to these filters goes to the outside wall. Use the PVC weld adhesive to stick the small tube you have cut to length onto the end flange of the extract fan and allow the adhesive to set. Protect the front cover at all times from dirt and scratches.

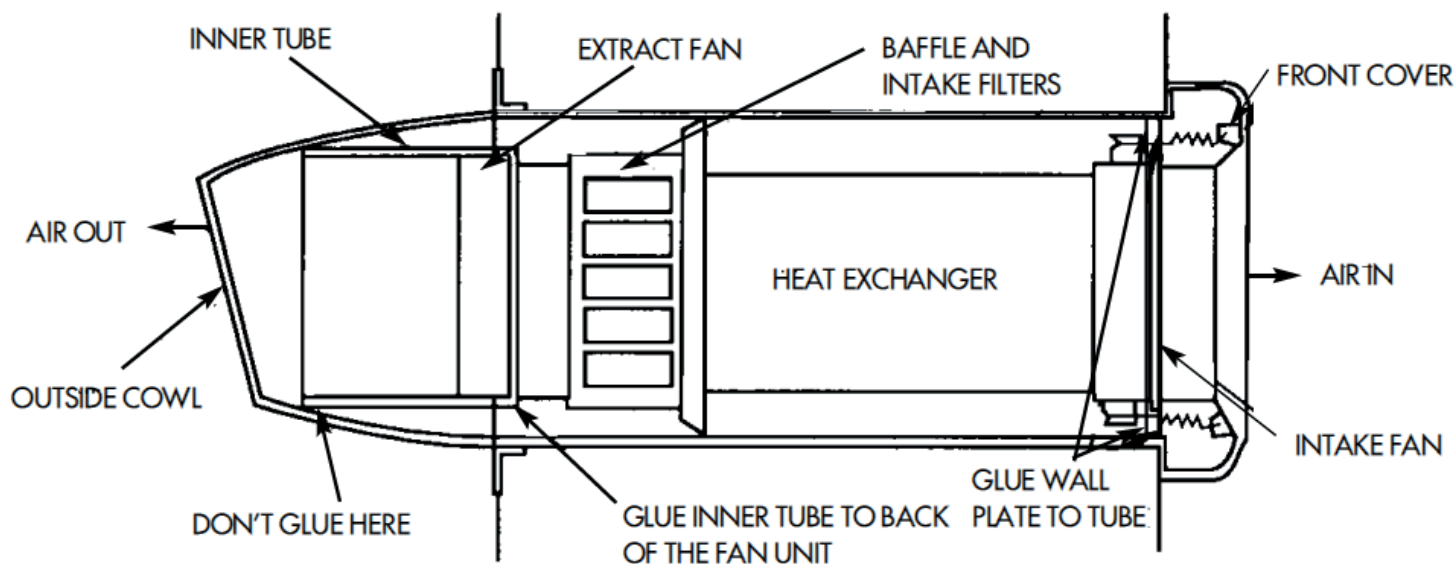

- k) Now fit the wall plate to the wall. The wall plate is marked top on the front face. If the sleeve on the rear wall plate does not fit into the drilled hole, carefully open up the hole in the plasterwork until the wall plate will fit flush against the wall and is central in the drilled hole. (Use the remnant piece of large diameter tube as a template to ensure it is central).

Mark out and drill the screw holes and chisel out a groove for the wiring from the cable entry hole (top left) upwards to the ceiling (or in the direction you have determined for the transformer or remote control). Fit screw plugs into the screw holes.

- l) Fit the wall plate onto the open end of the large tube with the outside cowl. Measure the distance from the back edge of the wall plate to the other end of the tube. The tube should not extend beyond the outside wall finisher.

Use the PVC weld adhesive to stick the wall plate to the outside tube. Ensure that the outside cowl is the right way up (louvres pointing downwards to avoid rain ingress and the louvres are level to the wall plate). Push the outside cowl / tube / wall plate assembly into the hole in the wall. Make sure that top is correctly positioned and pull the cable through the cable hole, check that there is a small downwards gradient in the tube (see section f). Screw the wall plate to the wall ensuring that it is level with the ceiling.

**It is important to do this now in order to accommodate the angle of the tube in the back of the wall plate before the glue sets.**

# Location of the Transformer/Humidity Sensor unit

Note: This part must not be mounted in the interior of a bath tub or shower basin and must be positioned out of reach of a person using a fixed bath or shower. It should be also positioned away from any source of water spray.

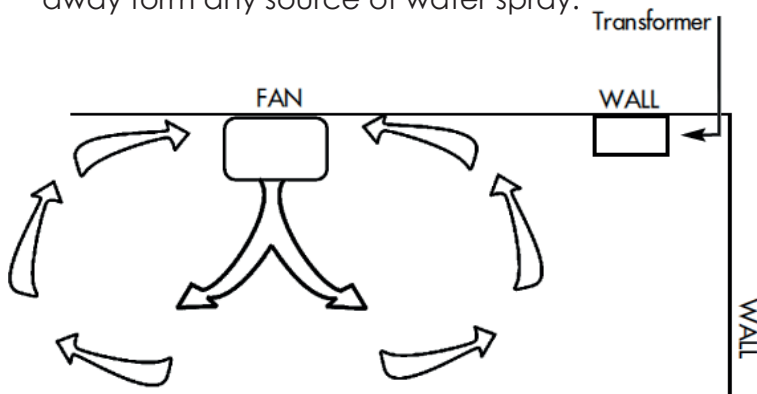

m) The Transformer / Humidity sensor unit may be mounted on the wall or ceiling.

Position the transformer / humidity unit at least 6" (150mm) from a corner to allow correct airflow over the humidity sensor. Also, ensure the humidity sensor unit is not directly in the stream of the fresh air coming in from the fan unit, as this will result in false sensing.

An ideal location is on the same wall, or one immediately adjacent which is in the stream of the stale / damp air being drawn into the side vents of the fan assembly.

**Wiring: IF IN DOUBT CONSULT A QUALIFIED ELECTRICIAN**

n) Decide how you are going to run the wires from the transformer to the fan unit. All wiring must be in accordance with current IEE wiring regulations.

A 5 amp two core power cable is required to connect the fan assembly to the remote control. A two core, 3 amp supply is required on the input mains connection. An earth connection is not required.

Pass the input and output wires through the cable hole in the base plate of the remote control and fasten it in position. (SEE DIAGRAM ON PAGE 2)

To comply with electrical safety regulations both input and output leads must be clamped to the unit using the saddle clamps provided.

o) Mains wiring for remote control and transformer:

Red or Brown wire → to live terminal  
Black or Grey wire → to neutral terminal

**Do not apply power to the transformer yet!**

No earth is required to the ventilator in accordance with IEE wiring regulations for SELV circuits.

All wiring must be 1mm Minimum, fixing securely to comply with IEE wiring regulations. If in doubt consult a qualified electrician.

# Location of the Transformer/Humidity Sensor unit - 2

- p) Follow the line diagram below to make the correct connections between the fan assembly and the transformer/humidity sensor, and wall plate.
- q) Place the fan assembly and front cover through the wall plate and push home. Apply power to the system and check operation. Conduct a smoke test to ensure the extract fan is running. Check that the front filters are in place and screw the front cover to the wall plate with the screws provided.

**NOTE:** If the unit has automatically switched to boost due to high humidity in the room, the pull cord switch will have no effect until the humidity drops below the preset level:

**IMPORTANT:** The pull cord manually switches the fan unit from trickle to boost. If the pull cord option is not required, when the installation is complete remove the cord ensuring that the switch is in the TRICKLE position. The LED shown on page 2, being extinguished, confirms this.

- r) After the system has run for some time, check the fan unit switches to boost by directing steam from a kettle over the remote control unit.
- s) The fan's continuous trickle speed has been factory set. However, if it is found that the fan is audible at this setting, it is possible to reduce the trickle speed still further. Remove the lid of the control box, and move the fuse link from **fast** trickle to **slow** trickle position (see diagram below). Always replace the fuse with one of the correct type and rating.

## Transformer/Humidity Sensor unit Wiring

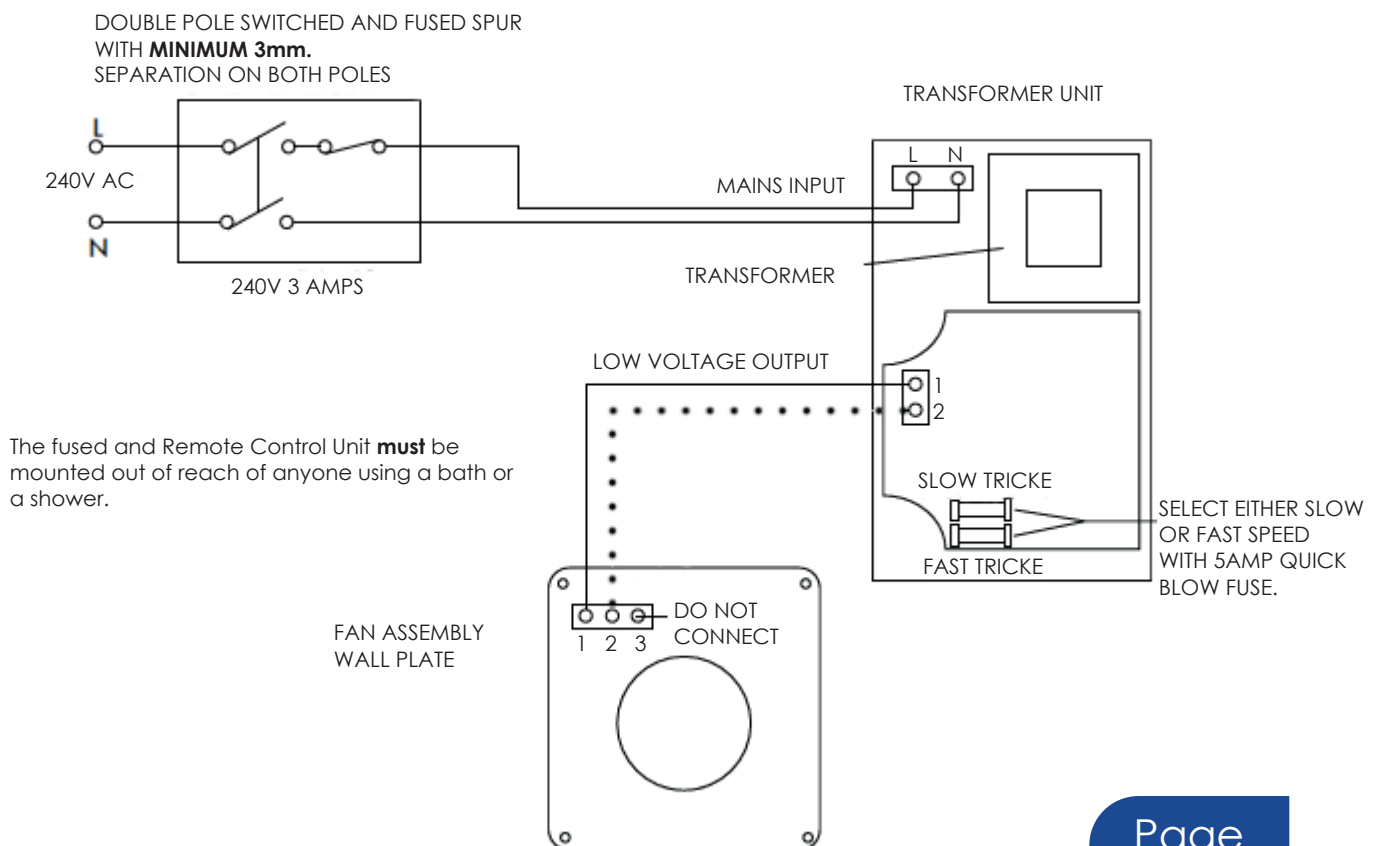



## Light Level Sensor

A Light Level Sensor is included to prevent the fan from switching automatically to boost at nighttime. This is a useful feature particularly if the Heat Recovery Ventilator is installed in a bedroom or bed-sit accommodation, ensuring noise is kept to a minimum.

The sensor is factory set in the OFF position as this is preferred for most installations. This means that the automatic boost feature will operate if the humidity rises during the hours of darkness. To activate the light sensing feature, (boost inhibited during darkness) turn the adjuster fully anti-clockwise, shown on page 2.

This should be an approximate setting for most installations depending on the location of the remote transformer/humidity assembly in the room.

Fine-tuning may be required for precise operation, especially in rooms with low energy light bulbs:

- Clockwise allows boost to operate during darkness
- Anti-clockwise prevents boost operating during darkness

A simple test for the correct setting is to trigger the boost feature via the humidity sensor in a darkened room. When switching the light on or off, the boost speed should cut in and out accordingly.

## Maintenance

Proper maintenance will allow the unit to perform at its maximum efficiency to control the humidity level within the room in which it is fitted. Proper maintenance will also prevent the internal fans switching to boost mode more frequently than is absolutely necessary. Our recommendations are as follows:

- The readily accessible room grille filters which filter the outgoing air should be checked and cleaned at least every 2 to 3 months. This simple procedure can easily be undertaken by the tenant/occupier/owner of the dwelling.
- The two larger filters within the main section of the fan assembly are accessed via screws for added safety and should be undertaken by the installers, an experienced electrician or person familiar with the KHRV150 fan. Experience has shown that this procedure is best undertaken at least annually (if you have any queries regarding the annual servicing of these fans, please contact either your supplier).

### Tools required:

- 🌿 Crosshead Screwdriver  
*Or - if tamperproof screws used*
- 🌿 System Zero Tamperproof Screwdriver or Bit - (Part code - KTMP5 or KTMPB)

### WARNING:

- 🌿 The Transformer contains no user serviceable parts.
- 🌿 Ensure that these instructions are followed by a suitably competent person.
- 🌿 Familiarise yourself with this entire procedure prior to commencing.
- 🌿 Ensure that you are able to access the unit without placing yourself or any other person at risk so that you are not stretching unnecessarily to undertake this procedure.

## Front Facia Extract Filters:

- 1) Isolate the fan unit from the mains supply before commencing this procedure and wait for the fan blades to stop rotating.
- 2) Open the grille flaps on both sides of the unit front facia grille. Open the filter covers by gently pulling each cover in the direction marked by the arrow.
- 3) The filters can then be simply pulled out of the unit so that they may be cleaned.
- 4) The filters are easily washed in lukewarm water by holding the filters under running water (clean side of the filter facing up into the flow and the dirty side facing the sink/bucket) thus pushing the dirt away from the filter, an abrasive rubbing action between the fingers and filter often helps and in some cases a detergent will accelerate the cleaning process.
- 5) If the filters do not clean very well, then it may be time for replacements to be purchased. These are available from your local supplier.
- 6) Once the filters have been cleaned and dried thoroughly they can be inserted back in their intended location within the door/flaps at the side of the incoming airflow. The doors can then be closed and the filters will continue to clean the extracted air supply to prolong the life and improve the efficiency of the fan.

## Internal Rear Intake Filters:

- 7) Open the front filters covers to expose the four screws and unscrew. Once the screws have been completely removed, we recommend that the filter covers are then closed to hold the filters and covers in place.
- 8) Gently lever the main fan unit away from the wall (a small distance only at this stage i.e. 510mm). This will allow the front filter covers to be removed without losing, dropping or damaging them if required, although it should be possible to completely remove the main fan unit from the wall with the covers in place.
- 9) The main casing can then be gently removed completely from the wall ensuring that the external cowl and smaller 125mm separator tube are not damaged/disturbed.
- 10) Place the fan unit on a suitable flat surface/workbench and remove the larger filters from the sides of the unit situated between the rear fan and aluminium heat exchange unit - care should be taken to ensure that they are not damaged or torn.
- 11) The filters are easily washed in lukewarm water by holding the filters under running water (clean side of the filter facing up into the flow and the dirty side facing the sink/bucket) thus pushing the dirt away from the filter, an abrasive rubbing action between the fingers and filter often helps and in some cases a detergent will accelerate the cleaning process.
- 12) If the filters do not clean very well, then it may be time for replacements to be purchased. These are available from your local supplier.
- 13) Once the filters have been cleaned and dried thoroughly they can be carefully inserted back in their intended location within the white plastic housing between the rear fan and the aluminium heat exchange unit.
- 14) At this stage it may be wise to check the Aluminium Heat Exchange Unit to see if it needs to be cleaned/washed with a suitable dry cloth or fine brush - ensure the Heat Exchange Unit is dry and that the electrical connections are not damaged or disturbed.

## Internal Rear Intake Filters - Continued

- 15) Now the main fan unit is ready to be inserted back into the wall, ensure that the vital outer cowl assembly and 125mm separator tube (required for installation in walls which exceed 225mm depth) are still secured.
- 16) Ensure that the fan unit is inserted the correct way up so that the electrical connection/terminal block will be made properly and that the front filter covers (if not already fixed) are located prior to the unit being 'pushed home' to the wall plate (i.e. it will be impossible to insert the filter covers unless if the fan unit and wall plate are secured).
- 17) Once the fan has been re-instated in the wall and the mains is switched on the filters will continue to clean the incoming air supply to prolong the life and improve the efficiency of the fan.

Included parts		Optional Parts
VENTILATION UNIT	CONTROL UNIT	EXTENSION KIT
1 Outer cowl	12 Control unit	A Outer extension kit tube (colour may vary)
2 Finishing ring	13 Thumbwheel	B Inner extension kit tube (colour may vary)
3 Outer tube	14 Pull cord	<b>OTHER PARTS</b>
4 Inner tube	15 Thumbwheel cover	C Hygrometer (SELLS-HYGRO)
5 Extract motor	<b>SCREWS</b>	D Tamperproof bit (K-TMPB)
6 Intake filters	16 Standard screws	
7 Heat exchanger	17 Tamperproof screws	
8 Supply motor		
9 Side filter flap		
10 Extract filter		
11 Front facia grill		

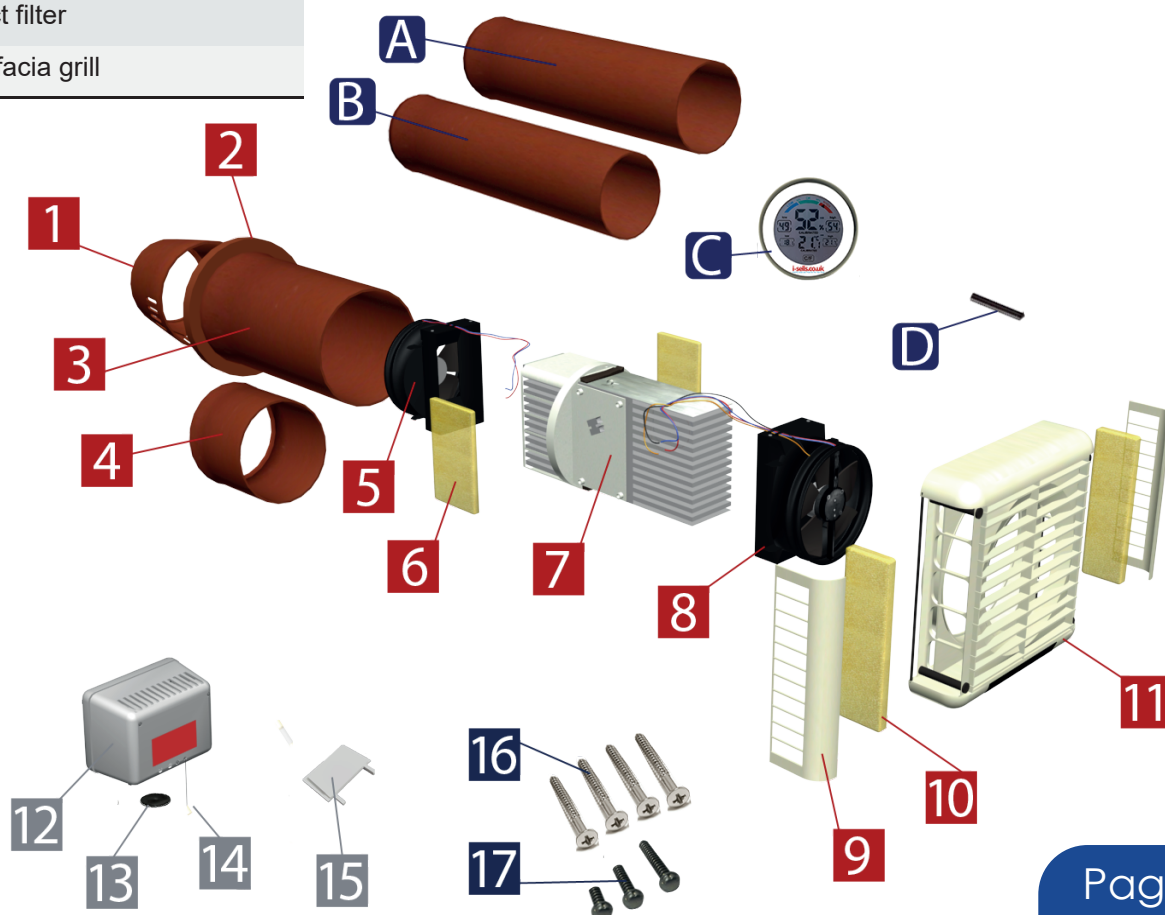

# Registration

Register your unit online now. If you register within 14 days of purchase you will receive an extra filter set free.

## Step 1

You will need the following information to hand to register your first set of replacement filters **FREE**.

- 🌿 The serial number of your HRV unit. *(Found on the packaging box or inside left filter cover)*
- 🌿 Date of purchase.
- 🌿 Your full name and address - including post code
- 🌿 Your email address



## Step 2

Fill in the online form, visit [www.kair.co.uk/register](http://www.kair.co.uk/register) or scan this QR code.

## Step 3

Once we have received your fully completed registration we will despatch your **FREE** filters by Royal Mail.

## The **Kair** warranty

Applicable only to products installed and used in the United Kingdom. For details of guarantee outside of United Kingdom, contact your local supplier.

**Kair** guarantees its products for two years from date of purchase against faulty material or workmanship. In the event of any part being found to be defective, the product will be repaired, or at the Company's option replaced, without charge, provided that the product:

- 🌿 Has been maintained / serviced in accordance with instructions given.
- 🌿 Has been installed and used in accordance with the instructions given with each unit.
- 🌿 Has not been connected to an unsuitable electrical supply.
- 🌿 Has not been subject to misuse, neglect or damage.
- 🌿 Has not been modified or repaired by any person not authorised by the company.

## IF CLAIMING UNDER TERMS OF GUARANTEE

Please return the complete product, carriage paid to your original supplier or nearest **Kair** centre, by post. Please ensure that it is adequately packed and accompanied by a letter clearly marked "*Guarantee Claim*" stating the nature of the fault and providing evidence of date and source of purchase.

The guarantee is offered to you as an extra benefit, and does not effect you legal rights.



📞 **Phone:** 020 8463 9695  
🌐 **Web:** [www.kair.co.uk](http://www.kair.co.uk)  
@ **Email:** [info@kair.co.uk](mailto:info@kair.co.uk)  
📍 **Address:** 9A-11, High Street, Sidcup, DA14 6EN

As part of our policy of continuous product development, Kair reserves the right to alter specifications without notice.

Version: 20221104