

 **monsoon**
PMF Range

Medium Duty Plate Fans 200mm - 630mm

AVAILABLE NOW FROM

i-sells.co.uk



Showroom:

15 St John's Parade
Sidcup High Street
DA14 6ES

EMAIL: sales@i-sells.co.uk
SALES: 020 8463 9696
WEB: www.i-sells.co.uk



 **NATIONAL
VENTILATION**

Stathe Road
Burrowbridge
Somerset
TA7 0RY

Sales & Technical: 01823 690290
Email: info@nvagroup.co.uk
Fax: 01823 690291
www.nationalventilation.co.uk



monsoon PMF Range

A range of low pressure axial fans single and three phase, in steel casing with the air capacity up to 11,900m³/h for wall mounting on a square plate.

Models available

Code	Description
Single Phase	
PMF-200/2/1	200mm Single ph. 2 Pole (860m ³ /h)
PMF-250/4/1	250mm Single ph. 4 Pole (1,050m ³ /h)
PMF-300/4/1	300mm Single ph. 4 Pole (1,340m ³ /h)
PMF-350/4/1	350mm Single ph. 4 Pole (2,500m ³ /h)
PMF-400/4/1	400mm Single ph. 4 Pole (3,580m ³ /h)
PMF-450/4/1	450mm Single ph. 4 Pole (4,680m ³ /h)
PMF-500/4/1	500mm Single ph. 4 Pole (7,060m ³ /h)
PMF-560/4/1	560mm Single ph. 4 Pole (8,800m ³ /h)
PMF-630/4/1	630mm Single ph. 4 Pole (11,900m ³ /h)
Three Phase	
PMF-300/4/3	300mm Three ph. 4 Pole (1,310m ³ /h)
PMF-450/4/3	450mm Three ph. 4 Pole (5,280m ³ /h)

AVAILABLE NOW FROM
i-sells.co.uk



Showroom:
15 St John's Parade
Sidcup High Street
DA14 6ES

EMAIL: sales@i-sells.co.uk
SALES: 020 8463 9696
WEB: www.i-sells.co.uk

Features

- Fan casing and impeller are made from steel with polymeric coating
- Asynchronous ball bearing motor for long service life
- External rotor motor with built-in thermal protection
- Motor protection rating IP44
- Fully speed controllable
- Inlet steel finger guard as standard
- Other sizes available on request



**NATIONAL
VENTILATION**

Stathe Road
Burrowbridge
Somerset
TA7 0RY

Sales & Technical: 01823 690290
Email: info@nvagroup.co.uk
Fax: 01823 690291
www.nationalventilation.co.uk



Showroom:
15 St John's Parade
Sidcup High Street
DA14 6ES

EMAIL: sales@i-sells.co.uk
SALES: 020 8463 9696
WEB: www.i-sells.co.uk

Technical - Single Phase

Model	PMF200/2/1	PMF250/4/1	PMF300/4/1	PMF350/4/1	PMF400/4/1	PMF450/4/1	PMF500/4/1	PMF550/4/1	PMF630/4/1
Voltage	230	230	230	230	230	230	230	230	230
Power (W)	55	50	75	140	180	250	420	550	750
Current (A)	0.26	0.22	0.35	0.65	0.82	1.2	1.95	2.55	3.5
Maximum Air Flow m ³ /h	860	800	1340	2500	3580	4680	7060	8800	11900
RPM	2300	1380	1350	1380	1380	1350	1300	1300	1360
Noise level @ 3mtr	50	55	58	62	63	64	69	70	75
Max temperature (°C)	-30 +60	-30 +60	-30 +60	-30 +60	-30 +60	-30 +60	-30 +60	-30 +60	-30 +60
Protection rating	IP24	IP24	IP24	IP24	IP24	IP24	IP24	IP24	IP24
Weight (kg)	3.9	4.1	5.1	7.1	8.8	10.6	14.2	16.6	22.6

Technical - Three Phase

Model	PMF300/4/3	PMF450/4/3
Voltage	400	400
Power (W)	75	180
Current (A)	0.22	0.47
Maximum Air Flow m ³ /h	1310	3740
RPM	1380	1380
Noise level @ 3mtr	58	64
Max temperature (°C)	-30 +60	-30 +60
Protection rating	IP24	IP24
Weight (kg)	4.1	10.6



 **NATIONAL VENTILATION**

Stathe Road
Burrowbridge
Somerset
TA7 0RY

Sales & Technical: 01823 690290
Email: info@nvagroup.co.uk
Fax: 01823 690291
www.nationalventilation.co.uk



Showroom:
15 St John's Parade
Sidcup High Street
DA14 6ES

EMAIL: sales@i-sells.co.uk
SALES: 020 8463 9696
WEB: www.i-sells.co.uk

Dimensions

Model	PMF 200	PMF 250	PMF 300	PMF 350	PMF400	PMF450	PMF500	PMF550	PMF630
∅ D	210	260	326	388	417	465	520	570	650
∅ d	7	7	9	9	9	11	11	11	11
B	312	370	430	485	540	576	655	725	800
B1	260	320	380	435	490	535	615	675	710
L	145	155	155	200	240	250	260	280	295

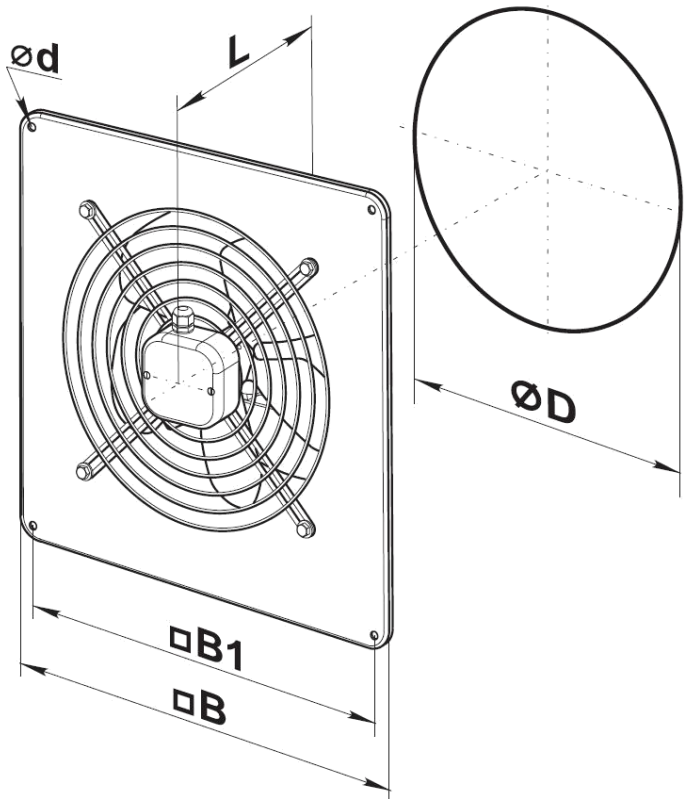

Stathe Road
Burrowbridge
Somerset
TA7 0RY

Sales & Technical: 01823 690290
Email: info@nvagroup.co.uk
Fax: 01823 690291
www.nationalventilation.co.uk



monsoon PMF Range

Performance Single Phase

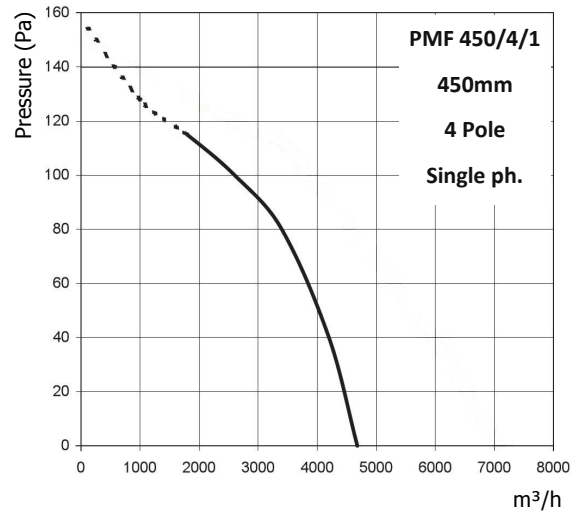
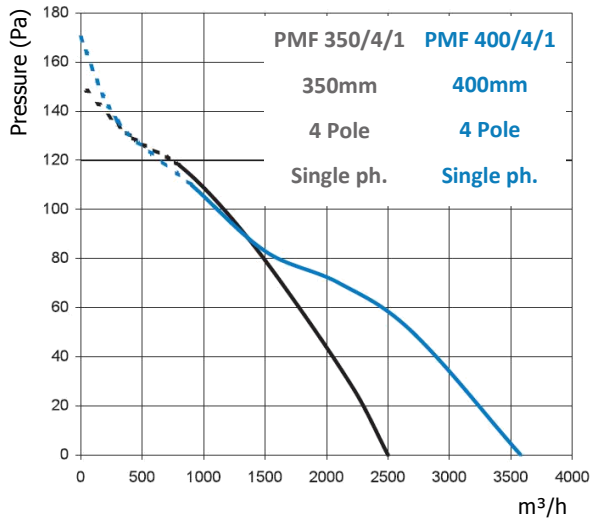
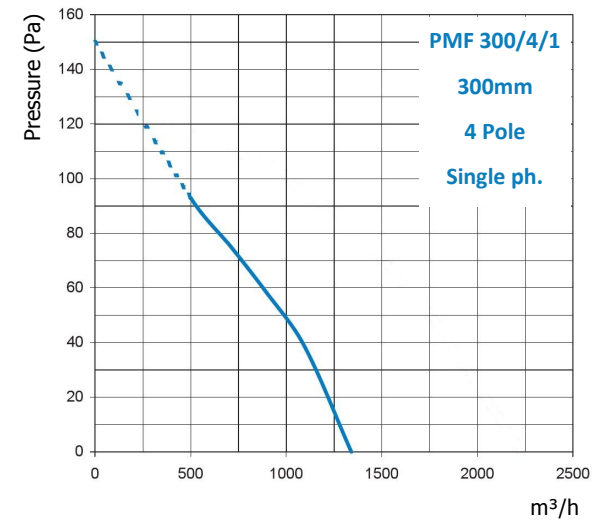
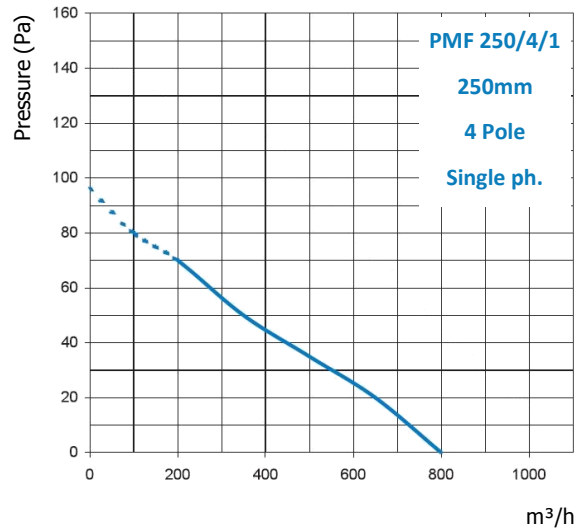
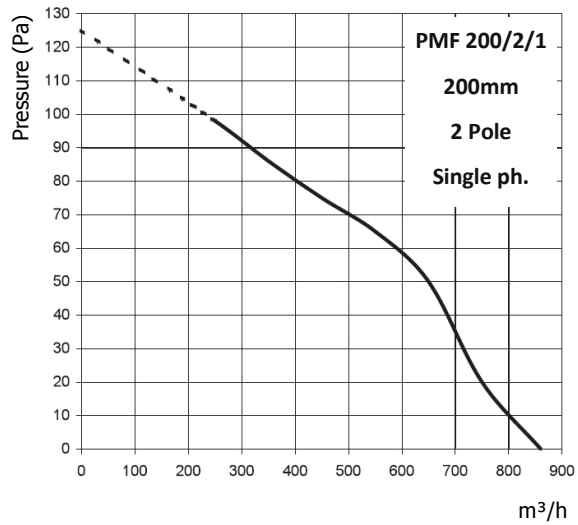

AVAILABLE NOW FROM
i-sells.co.uk



Showroom:
15 St John's Parade
Sidcup High Street
DA14 6ES

EMAIL: sales@i-sells.co.uk
SALES: 020 8463 9696
WEB: www.i-sells.co.uk



Stathe Road
Burrowbridge
Somerset
TA7 0RY

Sales & Technical: 01823 690290
Email: info@nvagroup.co.uk
Fax: 01823 690291
www.nationalventilation.co.uk

Performance Single Phase

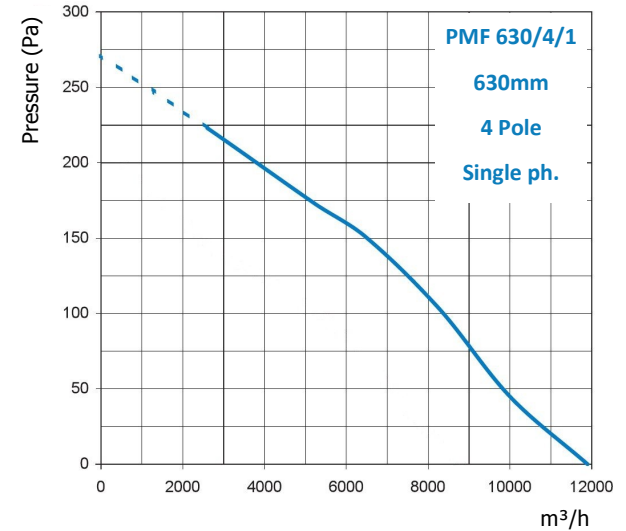
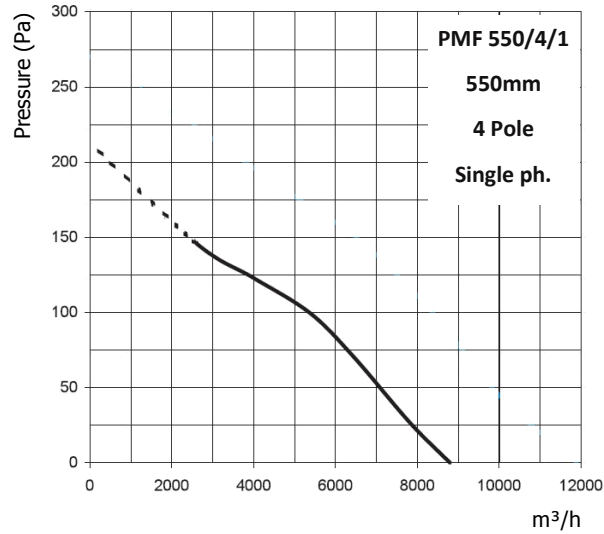
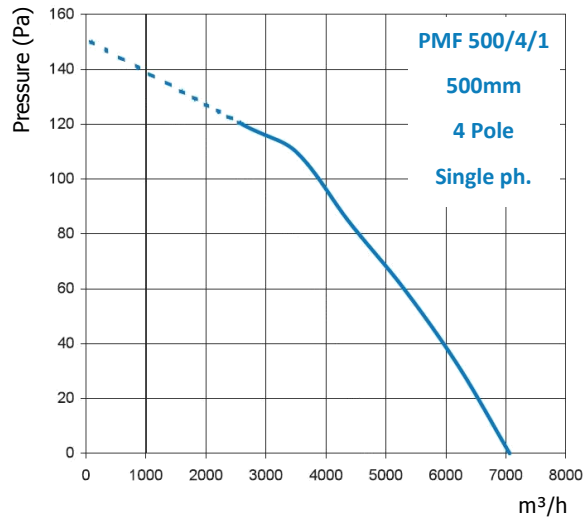

Performance Three Phase

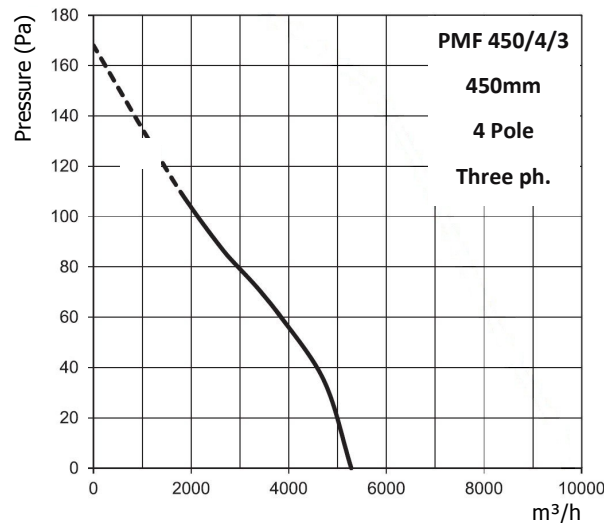
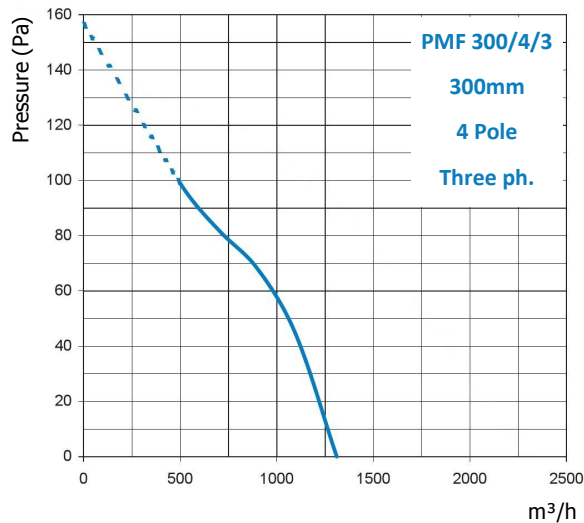

Stathe Road
 Burrowbridge
 Somerset
 TA7 0RY

Sales & Technical: 01823 690290
 Email: info@nvagroup.co.uk
 Fax: 01823 690291
 www.nationalventilation.co.uk



AVAILABLE NOW FROM

i-sells.co.uk



Showroom:

15 St John's Parade
Sidcup High Street
DA14 6ES

EMAIL: sales@i-sells.co.uk
SALES: 020 8463 9696
WEB: www.i-sells.co.uk



Stathe Road
Burrowbridge
Somerset
TA7 0RY

Sales & Technical: 01823 690290
Email: info@nvagroup.co.uk
Fax: 01823 690291
www.nationalventilation.co.uk